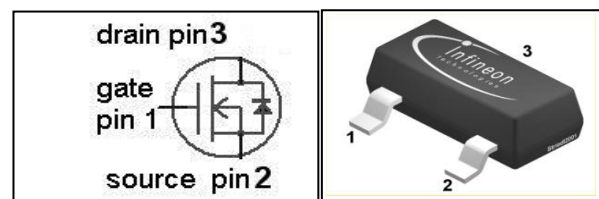

SIPMOS[®] Small-Signal-Transistor
Features

- N-channel
- Depletion mode
- dv/dt rated
- Available with $V_{GS(th)}$ indicator on reel
- Pb-free lead-plating; RoHS compliant
- Halogen-free according to AEC61249-2-21
- Qualified according to AEC Q101

Product Summary

| | | |
|------------------|------|----------|
| V_{DS} | 100 | V |
| $R_{DS(on),max}$ | 12 | Ω |
| $I_{DSS,min}$ | 0.09 | A |

PG-SOT-23

| Type | Package | Pb-free | Tape and Reel Information | Marking |
|--------|-----------|---------|---|---------|
| BSS169 | PG-SOT-23 | Yes | H6327: 3000 pcs/reel | SFs |
| BSS169 | PG-SOT-23 | Yes | H6906: 3000 pcs/reel sorted in $V_{GS(th)}$ bands ¹⁾ | SFs |

Maximum ratings, at $T_j=25\text{ °C}$, unless otherwise specified

| Parameter | Symbol | Conditions | Value | Unit |
|-------------------------------------|-------------------|---|-------------|--------------------|
| Continuous drain current | I_D | $T_A=25\text{ °C}$ | 0.17 | A |
| | | $T_A=70\text{ °C}$ | 0.14 | |
| Pulsed drain current | $I_{D,pulse}$ | $T_A=25\text{ °C}$ | 0.68 | |
| Reverse diode dv/dt | dv/dt | $I_D=0.19\text{ A}$, $V_{DS}=20\text{ V}$, $di/dt=200\text{ A}/\mu\text{s}$, $T_{j,max}=150\text{ °C}$ | 6 | kV/ μs |
| Gate source voltage | V_{GS} | | ± 20 | V |
| ESD Class | | JESD22-A114-HBM | Class 0 | |
| Power dissipation | P_{tot} | $T_A=25\text{ °C}$ | 0.36 | W |
| Operating and storage temperature | T_j , T_{stg} | | -55 ... 150 | $^{\circ}\text{C}$ |
| IEC climatic category; DIN IEC 68-1 | | | 55/150/56 | |

¹⁾ see table on next page and diagram 11

| Parameter | Symbol | Conditions | Values | | | Unit |
|-----------|--------|------------|--------|------|------|------|
| | | | min. | typ. | max. | |

Thermal characteristics

| | | | | | | |
|--|------------|-------------------|---|---|-----|-----|
| Thermal resistance, junction - ambient | R_{thJA} | minimal footprint | - | - | 250 | K/W |
|--|------------|-------------------|---|---|-----|-----|

Electrical characteristics, at $T_j=25\text{ }^\circ\text{C}$, unless otherwise specified
Static characteristics

| | | | | | | |
|----------------------------------|---------------|---|------|------|------|---------------|
| Drain-source breakdown voltage | $V_{(BR)DSS}$ | $V_{GS}=-10\text{ V}, I_D=250\text{ }\mu\text{A}$ | 100 | - | - | V |
| Gate threshold voltage | $V_{GS(th)}$ | $V_{DS}=3\text{ V}, I_D=50\text{ }\mu\text{A}$ | -2.9 | -2.2 | -1.8 | |
| Drain-source cutoff current | $I_{D(off)}$ | $V_{DS}=100\text{ V}, V_{GS}=-10\text{ V}, T_j=25\text{ }^\circ\text{C}$ | - | - | 0.1 | μA |
| | | $V_{DS}=100\text{ V}, V_{GS}=-10\text{ V}, T_j=125\text{ }^\circ\text{C}$ | - | - | 10 | |
| Gate-source leakage current | I_{GSS} | $V_{GS}=20\text{ V}, V_{DS}=0\text{ V}$ | - | - | 10 | nA |
| On-state drain current | I_{DSS} | $V_{GS}=0\text{ V}, V_{DS}=10\text{ V}$ | 90 | - | - | mA |
| Drain-source on-state resistance | $R_{DS(on)}$ | $V_{GS}=0\text{ V}, I_D=0.05\text{ A}$ | - | 5.3 | 12 | Ω |
| | | $V_{GS}=10\text{ V}, I_D=0.19\text{ A}$ | - | 2.9 | | |
| Transconductance | g_{fs} | $ V_{DS} >2 I_D R_{DS(on)max}, I_D=0.15\text{ A}$ | | 0.20 | - | S |

Threshold voltage $V_{GS(th)}$ sorted in bands²⁾

| | | | | | | |
|---|--------------|--|-------|---|-------|---|
| J | $V_{GS(th)}$ | $V_{DS}=3\text{ V}, I_D=50\text{ }\mu\text{A}$ | -2 | - | -1.8 | V |
| K | | | -2.15 | - | -1.95 | |
| L | | | -2.3 | - | -2.1 | |
| M | | | -2.45 | - | -2.25 | |
| N | | | -2.6 | - | -2.4 | |

²⁾ Each reel contains transistors out of one band whose identifying letter is printed on the reel label. A specific band cannot be ordered separately.

| Parameter | Symbol | Conditions | Values | | | Unit |
|-----------|--------|------------|--------|------|------|------|
| | | | min. | typ. | max. | |

Dynamic characteristics

| | | | | | | |
|------------------------------|--------------|---|---|-----|-----|----|
| Input capacitance | C_{iss} | $V_{GS}=-10\text{ V}, V_{DS}=25\text{ V},$ $f=1\text{ MHz}$ | - | 51 | 68 | pF |
| Output capacitance | C_{oss} | | - | 9 | 13 | |
| Reverse transfer capacitance | C_{rss} | | - | 4 | 7 | |
| Turn-on delay time | $t_{d(on)}$ | $V_{DD}=50\text{ V},$ $V_{GS}=-3\dots 7\text{ V},$ $I_D=0.12\text{ A}, R_{G,ext}=6\ \Omega$ | - | 2.9 | 4.2 | ns |
| Rise time | t_r | | - | 2.7 | 4.0 | |
| Turn-off delay time | $t_{d(off)}$ | | - | 11 | 17 | |
| Fall time | t_f | | - | 27 | 40 | |

Gate Charge Characteristics

| | | | | | | |
|-----------------------|---------------|--|---|-------|------|----|
| Gate to source charge | Q_{gs} | $V_{DD}=80\text{ V}, I_D=0.12\text{ A},$ $V_{GS}=-3\text{ to }7\text{ V}$ | - | 0.12 | 0.16 | nC |
| Gate to drain charge | Q_{gd} | | - | 0.9 | 1.4 | |
| Gate charge total | Q_g | | - | 2.1 | 2.8 | |
| Gate plateau voltage | $V_{plateau}$ | | - | -0.43 | - | V |

Reverse Diode

| | | | | | | |
|----------------------------------|---------------|---|---|------|------|----|
| Diode continuous forward current | I_S | $T_A=25\text{ }^\circ\text{C}$ | - | - | 0.19 | A |
| Diode pulse current | $I_{S,pulse}$ | | - | - | 0.76 | |
| Diode forward voltage | V_{SD} | $V_{GS}=-10\text{ V}, I_F=0.19\text{ A},$ $T_j=25\text{ }^\circ\text{C}$ | - | 0.82 | 1.2 | V |
| Reverse recovery time | t_{rr} | $V_R=50\text{ V}, I_F=0.12\text{ A},$ $di_F/dt=100\text{ A}/\mu\text{s}$ | - | 20.5 | 25.6 | ns |
| Reverse recovery charge | Q_{rr} | | - | 9.7 | 12.1 | nC |

1 Power dissipation

$$P_{tot}=f(T_A)$$

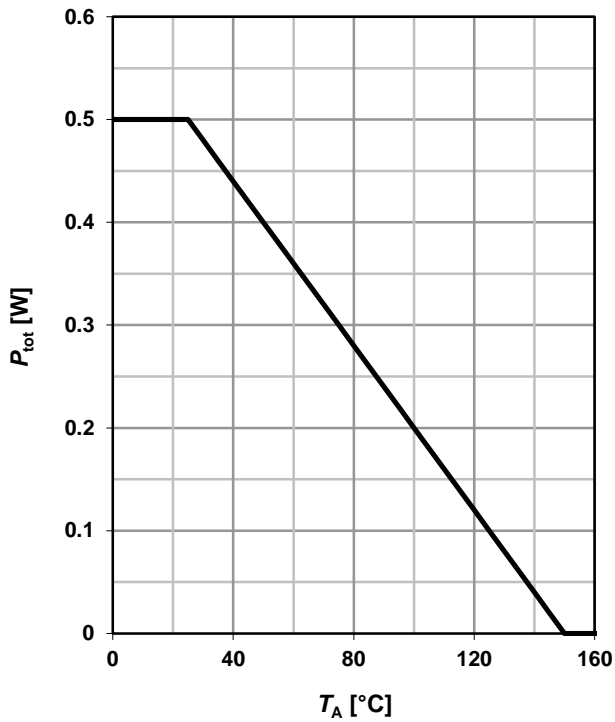

2 Drain current

$$I_D=f(T_A); V_{GS} \geq 10\text{ V}$$

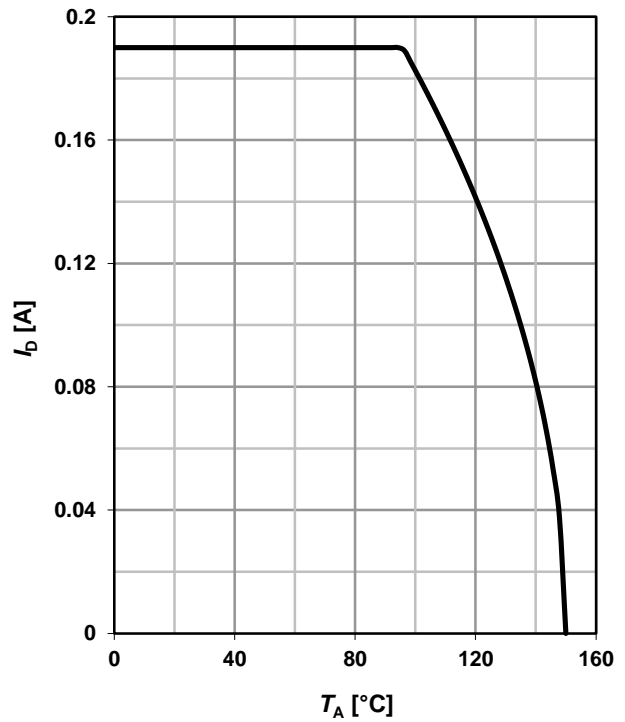

3 Safe operating area

$$I_D=f(V_{DS}); T_A=25\text{ °C}; D=0$$

parameter: t_p

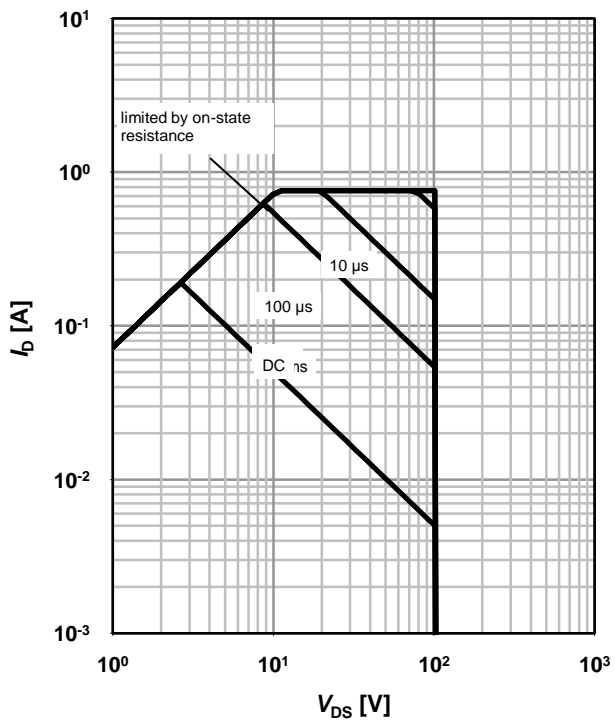

4 Max. transient thermal impedance

$$Z_{thJA}=f(t_p)$$

parameter: $D=t_p/T$

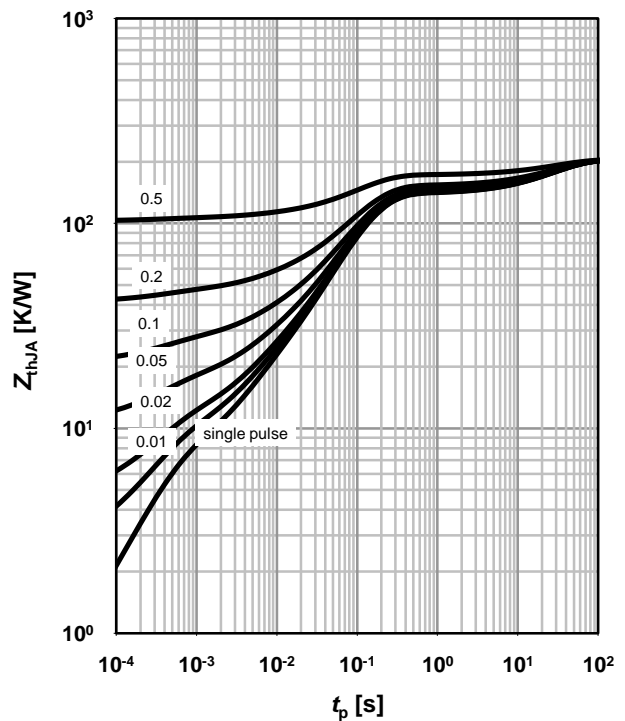

5 Typ. output characteristics

$I_D=f(V_{DS}); T_j=25\text{ }^\circ\text{C}$

parameter: V_{GS}

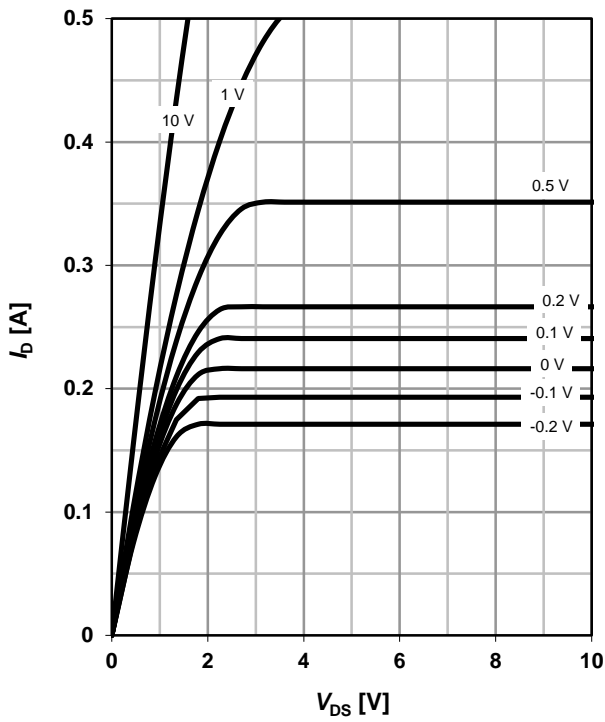

6 Typ. drain-source on resistance

$R_{DS(on)}=f(I_D); T_j=25\text{ }^\circ\text{C}$

parameter: V_{GS}

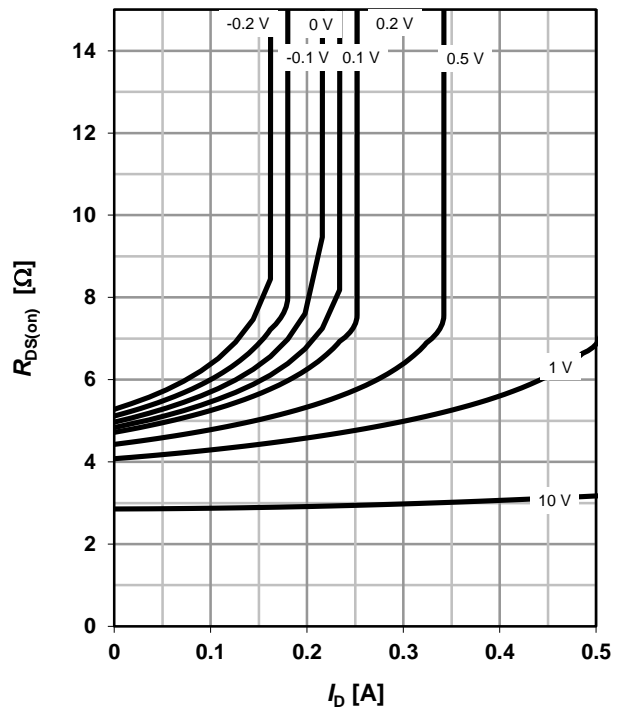

7 Typ. transfer characteristics

$I_D=f(V_{GS}); |V_{DS}|>2|I_D|R_{DS(on)max}$

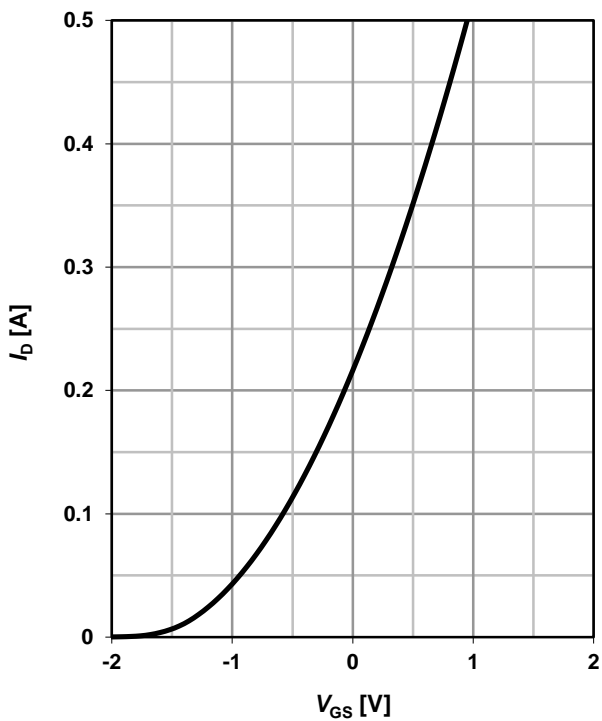

8 Typ. forward transconductance

$g_{fs}=f(I_D); T_j=25\text{ }^\circ\text{C}$

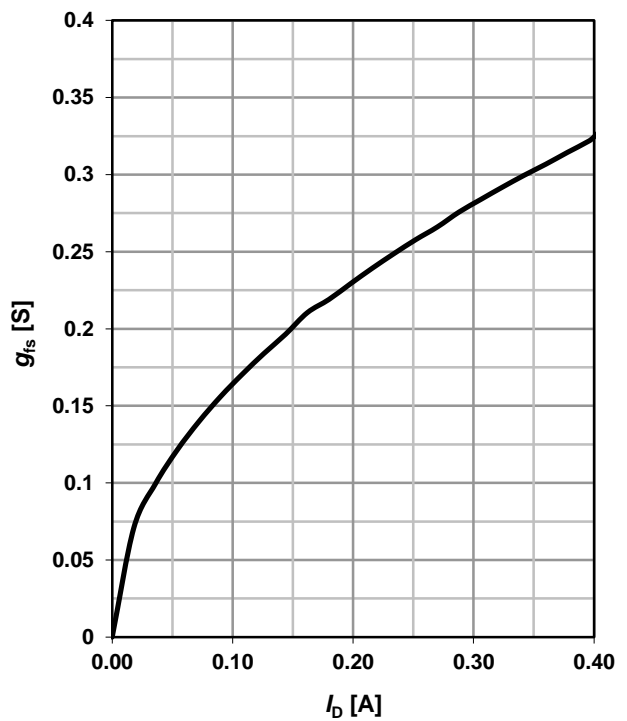

9 Drain-source on-state resistance

$R_{DS(on)}=f(T_j); I_D=0.05\text{ A}; V_{GS}=0\text{ V}$

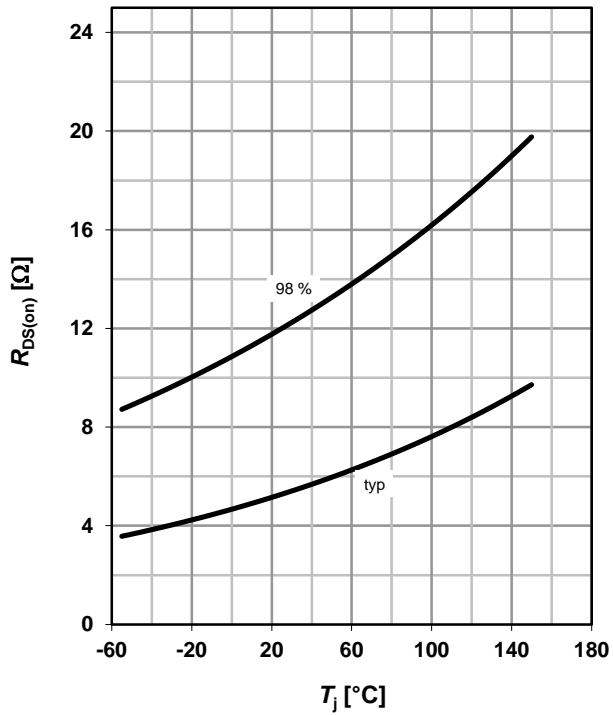

10 Typ. gate threshold voltage

$V_{GS(th)}=f(T_j); V_{DS}=3\text{ V}; I_D=50\text{ }\mu\text{A}$

parameter: I_D

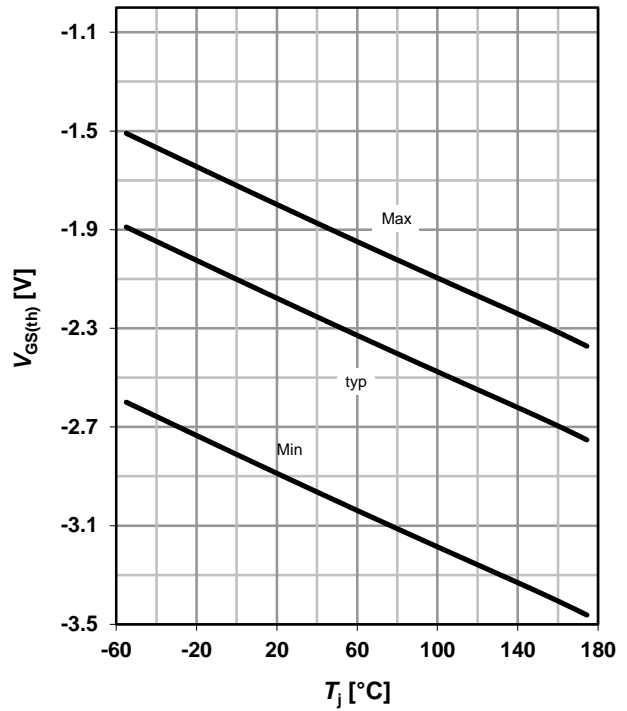

11 Threshold voltage bands

$I_D=f(V_{GS}); V_{DS}=3\text{ V}; T_j=25\text{ }^\circ\text{C}$

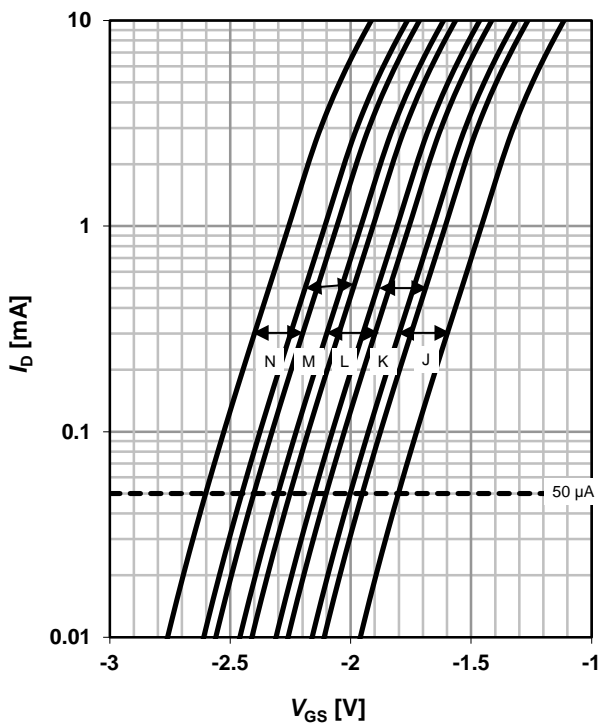

12 Typ. capacitances

$C=f(V_{DS}); V_{GS}=-10\text{ V}; f=1\text{ MHz}$

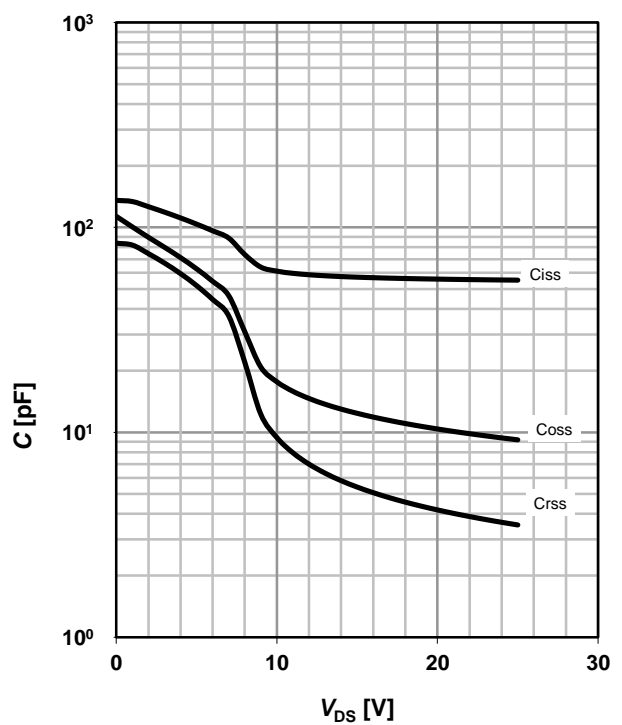

13 Forward characteristics of reverse diode

$$I_F = f(V_{SD})$$

parameter: T_j

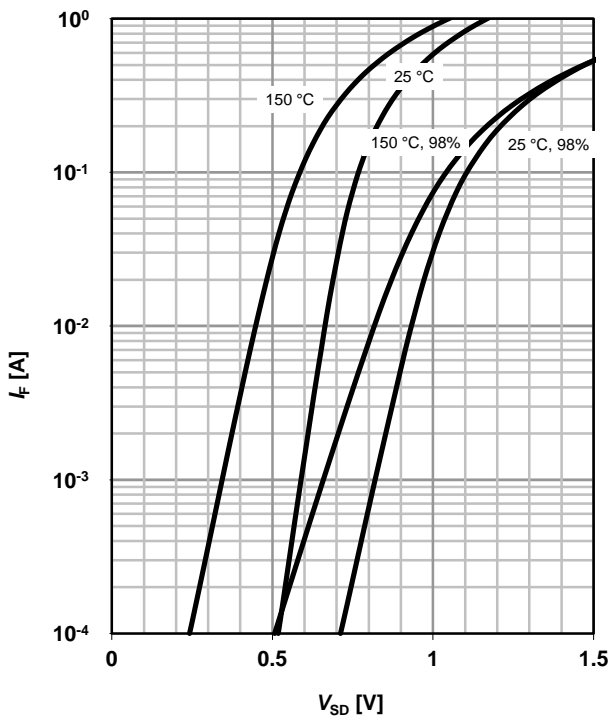

15 Typ. gate charge

$$V_{GS} = f(Q_{gate}); I_D = 0.12 \text{ A pulsed}$$

parameter: V_{DD}

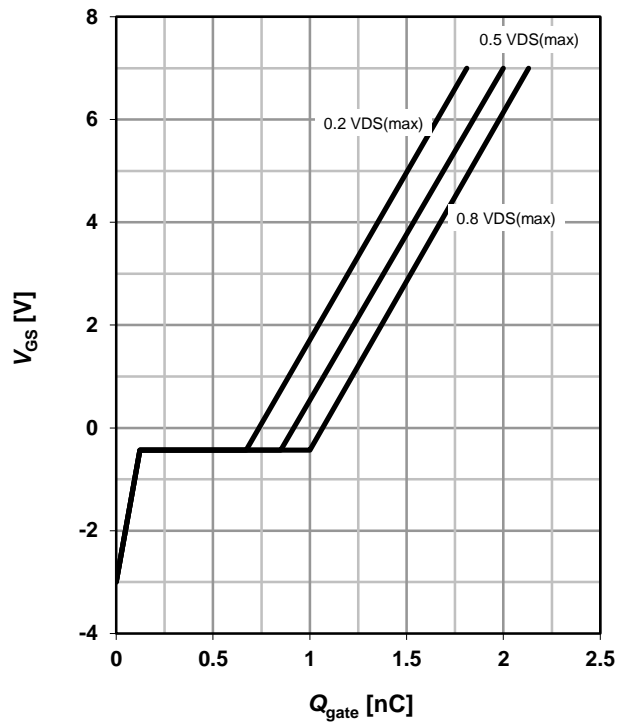

16 Drain-source breakdown voltage

$$V_{BR(DSS)} = f(T_j); I_D = 250 \mu\text{A}$$

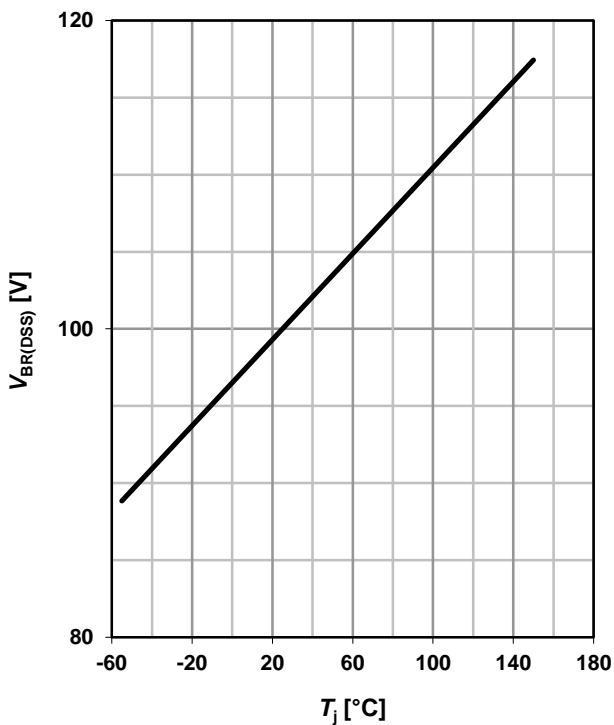

Package Outline:

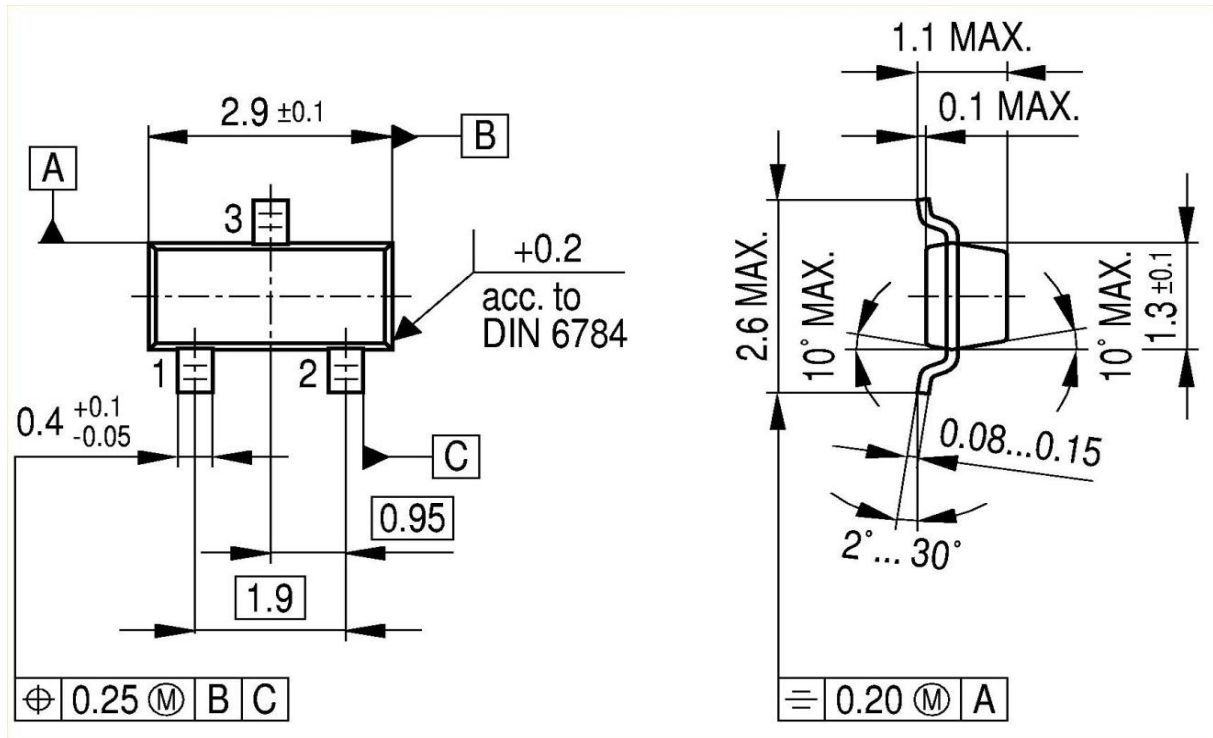

Footprint:

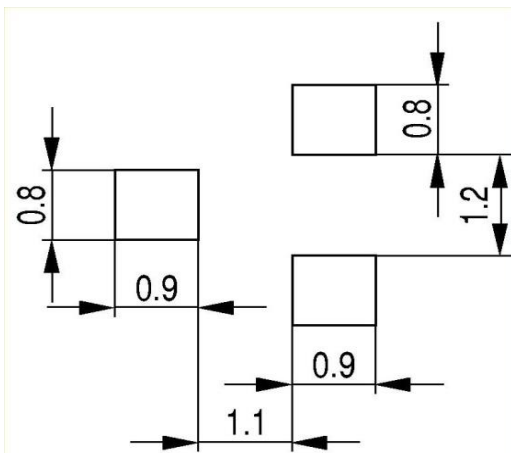

Packaging:

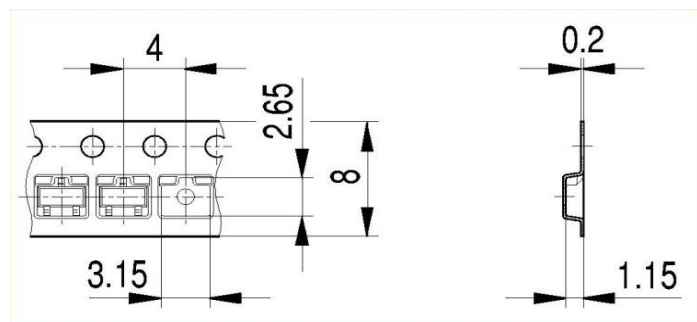

Dimensions in mm

Published by
Infineon Technologies AG
81726 Munich, Germany
© 2010 Infineon Technologies AG
All Rights Reserved.

Legal Disclaimer

The information given in this document shall in no event be regarded as a guarantee of conditions or characteristics. With respect to any examples or hints given herein, any typical values stated herein and/or any information regarding the application of the device, Infineon Technologies hereby disclaims any and all warranties and liabilities of any kind, including without limitation, warranties of non-infringement of intellectual property rights of any third party.

Information

For further information on technology, delivery terms and conditions and prices, please contact the nearest Infineon Technologies Office (www.infineon.com).

Warnings

Due to technical requirements, components may contain dangerous substances. For information on the types in question, please contact the nearest Infineon Technologies Office. Infineon Technologies components may be used in life-support devices or systems only with the express written approval of Infineon Technologies, if a failure of such components can reasonably be expected to cause the failure of that life-support device or system or to affect the safety or effectiveness of that device or system. Life support devices or systems are intended to be implanted in the human body or to support and/or maintain and sustain and/or protect human life. If they fail, it is reasonable to assume that the health of the user or other persons may be endangered.

单击下面可查看定价，库存，交付和生命周期等信息

[>>Infineon Technologies\(英飞凌\)](#)

[>>点击查看相关商品](#)